



NATURALS by Mod Cabinetry

CATALOG



NATURALS

BY MOD CABINETS

v 4.2.1

QUALITY

KNOW YOUR CABINETS

v 4.2.1

All American Sourced + Made

Mod Cabinetry sources, manufacturers and builds entirely in the USA. This way, you have the assurance that the craftsmanship is solid, the working conditions are respectable, and that there are no hidden toxic ingredients.

With hundreds of cabinetry brands in the marketplace it is often very difficult to find out where a certain brand’s components are made, where they are manufactured and assembled. Many brands use misleading terms such as “Built in the USA”, or “Made in the USA with globally sourced products” etc. When you dig a little deeper you will find that none of the popular brands are 100% sourced, manufactured and built in the USA.

Find out where your cabinets are really made:

<p>MADE IN USA SOURCED FROM USA MANUFACTURED IN USA ASSEMBLED IN USA</p>	<p>Until now, finding cabinetry that is 100% sourced, manufactured and built in the USA meant going to an expensive custom cabinet shop. Mod Cabinetry has changed that with its rigorous specifying process. With our high volume output, you get high quality parts at a fraction of the price of a local custom shop for the same specifications.</p>
<p>BUILT IN USA SOURCED FROM CHINA MANUFACTURED IN USA ASSEMBLED IN USA</p>	<p>The vast majority of big consumer brands source plywood, particle board, glides, runners and hinges in China. These imported parts are then used to manufacture and assemble cabinetry in the USA.</p>
<p>MADE IN CHINA SOURCED FROM CHINA MANUFACTURED IN CHINA ASSEMBLED IN USA</p>	<p>There are a number of brands that source and manufacture their cabinets including doors and drawers in China, then import them to the USA in flat packs and merely assemble them in the USA.</p>
<p>MADE IN CHINA SOURCED FROM CHINA MANUFACTURED IN CHINA ASSEMBLED IN CHINA</p>	<p>There are many contractor grade brands that are sourced, made and assembled entirely in China.</p>

Why We Use Columbia Forest Products

We chose Columbia Forest Products (CFP) for our plywood, MDF and furniture board. Founded in 1957, Columbia Forest Products is North America's largest manufacturer of hardwood plywood and hardwood veneer products. With headquarters in Greensboro, North Carolina, the employee-owned manufacturer has more than 2,000 employees and operates plants throughout the United States and Canada. All of CFP's plywood and veneer mills hold the FSC chain of custody certified by Rainforest Alliance.

With so many Chinese plywood imports and knock offs flooding the market we are committed to sourcing only US-made products for Mod Cabinetry. We use the following high-quality US-made Columbia Forest Products:

www.columbiaforestproducts.com



PureBond Hardwood Plywood

We use $\frac{3}{4}$ " no added formaldehyde hardwood plywood for the case work for Mod Cabinetry in category M-M3. Since 2005 CFP has manufactured over 50 million panels using its PureBond technology – a formaldehyde-free adhesive derived from food-grade soy flour. Unlike all other casework, this one has absolutely no added formaldehyde in the lamination or core assembly processes which means you will not introduce cancer-causing chemicals to your home.

Why we use Blum Hardware

We chose Blum USA, maker of hinges, glides and lift-ups for its US market in Stanley, North Carolina. Blum first started operations in the 1950's in Austria. When their high quality cabinetry parts became a favorite among custom cabinet shops in the United States they opened Blum USA in 1977. Today Blum USA has expanded to a high tech 450,000 square foot facility on over 70 acres. Blum Worldwide has 13,000 employees, with manufacturing in USA, Austria, Brazil and Poland and remains a private family owned business.

As with the casework, we are committed to sourcing only US-made products for Mod Cabinetry. We use the following high quality US-made Blum products:

www.blum.com

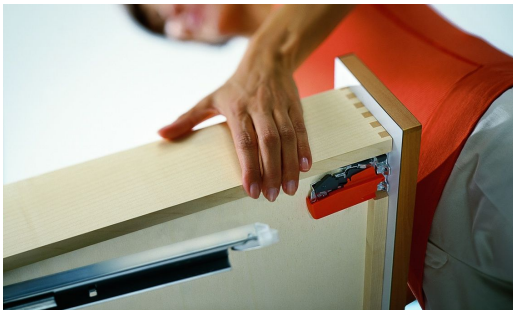

Blum Tandem Plus BluMotion

TANDEM plus BLUMOTION runners are the latest advancement in concealed runner technology. These top of line concealed full extension undermount drawers glides are added to our 5/8" solid wood dovetail drawers.



Blum Legrabox

Straight lines create the elegant look that defines LEGRABOX, the newest premium drawer system. The impressively slim 1/2" drawer sides in Matte Orion gray are the perfect compliment to the modern look of the Modello line.

Available as an upgrade for Modello Finishes

v 4.2.1



Blum AVENTOS

These heavy duty lift-ups keep the door out of the way no matter where they are stopped. Because of its unique opening action, it is ideal for cabinets above the refrigerator, accent cabinets, and wall cabinets.





Clip top BLUMOTION

Slamming doors are a thing of the past. These narrow aluminum 110 degree door hinges close silently because the BLUMOTION soft close feature is built into the hinge cup.





CABINET OPTIONS

MAKE ANY FINISH INTO THESE CABINETS TYPES



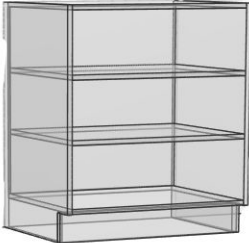

BASES

<p>1 SINGLE DRAWER</p>		<p>34-½" High x 24" Deep</p> <p>Width options:</p> <table border="0"> <tr> <td>12"</td> <td>21"</td> <td>33"</td> </tr> <tr> <td>15"</td> <td>24"</td> <td>36"</td> </tr> <tr> <td>18"</td> <td>27"</td> <td>39"</td> </tr> <tr> <td></td> <td>30"</td> <td>42"</td> </tr> </table>	12"	21"	33"	15"	24"	36"	18"	27"	39"		30"	42"	<p>Notes:</p> <ul style="list-style-type: none"> - 12"-24" are single door. Specify right (R) or left (L) hinge on cabinets -39" and 42" wide have a 2" center brace behind doors -(1) Adjustable 14 ½" deep shelf 			
12"	21"	33"																
15"	24"	36"																
18"	27"	39"																
	30"	42"																
<p>2 DRAWER + (2) ROLL OUTS</p>		<p>34-½" High x 24" Deep</p> <p>Width options:</p> <p>18" 30"</p>	<p>Notes:</p> <ul style="list-style-type: none"> - 18" is single door. Specify right (R) or left (L) hinge on cabinet -Rollouts are the same construction as the drawer type you choose. 															
<p>3 FULL HEIGHT +12" DEEP</p>		<p>34-½" High x 12" Deep</p> <p>Width options:</p> <table border="0"> <tr> <td>6"</td> <td>18"</td> <td>30"</td> </tr> <tr> <td>9"</td> <td>21"</td> <td>33"</td> </tr> <tr> <td>12"</td> <td>24"</td> <td>36"</td> </tr> <tr> <td>15"</td> <td>27"</td> <td>39"</td> </tr> <tr> <td></td> <td></td> <td>42"</td> </tr> </table>	6"	18"	30"	9"	21"	33"	12"	24"	36"	15"	27"	39"			42"	<p>Notes:</p> <ul style="list-style-type: none"> - 6"-24" are single door. Specify right (R) or left (L) hinge on cabinets -27"-42" have double door. -39" and 42" wide have a 2" center brace behind doors -(2) Adjustable full depth shelf - 6" wide always has slab door
6"	18"	30"																
9"	21"	33"																
12"	24"	36"																
15"	27"	39"																
		42"																

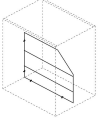
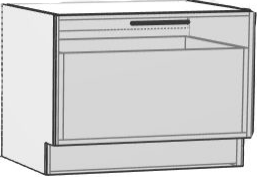

v 4.2.1



<p>4 FULL HEIGHT DOORS</p>		<p>34-½" High x 24" Deep</p> <p>Width options:</p> <table border="0"> <tr> <td>6"</td> <td>18"</td> <td>30"</td> </tr> <tr> <td>9"</td> <td>21"</td> <td>33"</td> </tr> <tr> <td>12"</td> <td>24"</td> <td>36"</td> </tr> <tr> <td>15"</td> <td>27"</td> <td>39"</td> </tr> <tr> <td></td> <td></td> <td>42"</td> </tr> </table>	6"	18"	30"	9"	21"	33"	12"	24"	36"	15"	27"	39"			42"	<p>Notes:</p> <ul style="list-style-type: none"> - 6"-24" are single door. Specify right (R) or left (L) hinge on cabinets -27"-42" have double door. -39" and 42" wide have a 2" (-2) adjustable 14.5" deep shelves - 6" wide always has slab door
6"	18"	30"																
9"	21"	33"																
12"	24"	36"																
15"	27"	39"																
		42"																
<p>5 BOOKSHELF</p>		<p>34-½" High x 24" Deep</p> <p>Width options:</p> <table border="0"> <tr> <td>21"</td> <td>30"</td> </tr> <tr> <td>24"</td> <td>33"</td> </tr> <tr> <td>27"</td> <td>36"</td> </tr> </table>	21"	30"	24"	33"	27"	36"	<p>Notes:</p> <ul style="list-style-type: none"> -Matching Interior -2 adjustable shelves -Comes with peg holes every 32mm 									
21"	30"																	
24"	33"																	
27"	36"																	
<p>6 TRASH PULLOUT</p>		<p>34-½" High x 24" Deep</p> <p>Width options:</p> <p>15" 18" 21"</p>	<p>Notes:</p> <ul style="list-style-type: none"> -Pull out unit is high-end Italian Compagnucci 349A; full extension soft close all aluminum. -This option costs more than chinese wire pullouts. It can endure the long-term repetitive use that a trash pullout is subject to. We think it is worth the added cost. -Door is mounted to unit. -Two 35 quart white bins. 															
<p>7 BASE PULLOUT</p>		<p>34-½" High x 24" Deep</p> <p>Width options:</p> <p>9" 12"</p>	<p>Notes:</p> <ul style="list-style-type: none"> · Door is mounted to pullout · Rack finish is made by Rev-a-shelf in natural wood · Full extension 100lb slides 															

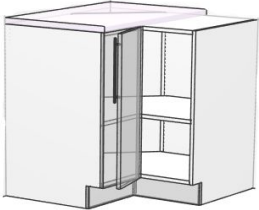
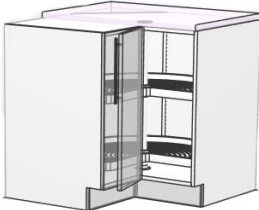
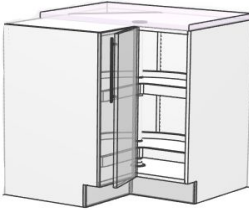

v 4.2.1

<p>8 TRAY DIVIDER</p>		<p>34-½" High x 24" Deep</p> <p>Width options: 12"</p>	<p>Notes: - Specify right R or left (L) hinge on cabinet - White wire tray divider comes unattached; site installation required</p> 
<p>9 BENCH SEAT</p>		<p>18" High x 24" Deep</p> <p>Width options: 24" 33" 27" 36" 30"</p>	<p>Note: - Drawer box is 8" high dovetail, 7" Legrabox, 5-7/8" - Full top</p>
<p>10 2 DRAWERS</p>		<p>34-½" High x 24" Deep</p> <p>Width options: 24" 33" 27" 36" 30"</p>	<p>Notes: Drawer boxes are 8" high for wood dovetail or 5 7/8" Metabox. Please consider the differences that the top and bottom drawer will have with a 14-7/8" drawer face and a shorter drawer box.</p>
<p>11 2 DRAWERS + INTERNAL DRAWER</p>		<p>34-½" High x 24" Deep</p> <p>Width options: 24" 33" 27" 36" 30"</p>	<p>Notes: The internal drawer box is 4" drawer located behind the top drawer front. The bottom drawer box is 8" high for wood dovetail and Legra or 5 7/8" Metabox. Please consider the differences that the bottom drawer will have with a 14-7/8" drawer face and a shorter drawer box.</p>
<p>12 3 DRAWERS</p>		<p>34-½" High x 24" Deep</p> <p>Width options: 12" 21" 15" 24" 18" 27"</p>	

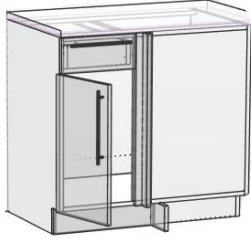
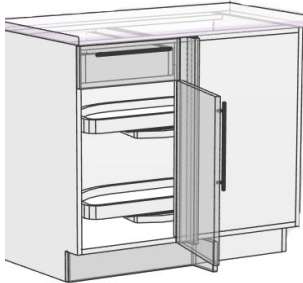
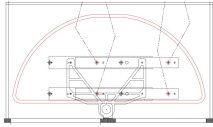
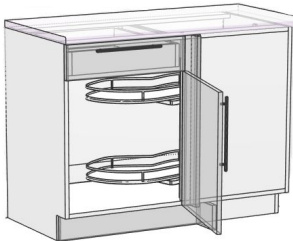

v 4.2.1

<p>13 3 DRAWER POTS & PANS</p>		<p>34-½" High x 24" Deep</p> <p>Width options: 30" 33" 36"</p>	<p>Notes: -With wood drawer box the 2-bottom drawers come with 100# rated heavy duty glides to support pots and pans.</p>
<p>14 4 DRAWERS</p>		<p>34-½" High x 24" Deep</p> <p>Width options: 12" 15" 18" 21"</p>	
<p>15 CORNER</p>		<p>34-½" High x 24" Deep</p> <p>Width options: 36" x 36"</p>	<p>Notes: -No accessories are included. -Knuckle hinge door -Specify R or L hinge</p>
<p>16 CORNER WITH PLASTIC</p>		<p>34-½" High x 24" Deep</p> <p>Width options: 36" x 36"</p>	<p>Notes: -Includes 28" white tension rod plastic lazy susan -Knuckle hinge door</p>
<p>17 CORNER WITH WOOD</p>		<p>34-½" High x 24" Deep</p> <p>Width options: 36" x 36"</p>	<p>Notes: -Includes wood lazy susan with stainless steel galley rails -Knuckle hinge door -Specify R or L hinge</p>

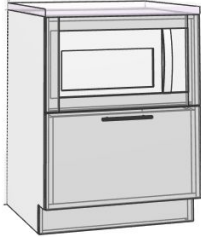
<p>18 BLIND CORNER</p>		<p>34-½" High x 24" Deep</p> <p>Width options: 39" (cabinet 36", door 11-5/8") 42" (cabinet 39", door 14-5/8") 45" (cabinet 42", door 17-5/8") 48" (cabinet 45", door 20-5/8") 51" (cabinet 39", door 23-5/8")</p>	<p>Choose right (R) or left (L) hinge side on order form. A left cabinet has the blind side on the left and the door on the right. Cabinet comes 3" shorter.</p> <p>Notes: -No accessories are included. -Pull your cabinet 3" away from wall to allow door to open.</p>
<p>19 BLIND CORNER WITH HALF MOON</p>		<p>34-½" High x 24" Deep</p> <p>Width options: 42" (cabinet 39", door 14-5/8") 45" (cabinet 42", door 17-5/8") 48" (cabinet 45", door 20-5/8")</p>	<p>Choose right (R) or left (L) hinge side on order form. A left cabinet has the blind side on the left and the door on the right. Cabinet comes 3" shorter.</p> <p>Notes: -Rev-a-shelf LD-4NW882 installed. -Pull your cabinet 3" away from wall to allow door to open.</p> 
<p>20 BLIND CORNER WITH LEMANS</p>		<p>34-½" High x 24" Deep</p> <p>Width options: 48" (cabinet 39", door 14-5/8") 51" (cabinet 42", door 17-5/8")</p>	<p>Choose right (R) or left (L) hinge side on order form. A left cabinet has the blind side on the left and the door on the right. Cabinet comes 3" shorter.</p> <p>Notes: -Hafele Lemans 541.32 installed. -Pull your cabinet 3" away from wall to allow door to open.</p>
<h1>SINK BASES</h1>			
<p>21 SINK FULL HEIGHT</p>		<p>34-½" High x 24" Deep</p> <p>Width options: 24" 36" 30" 39" 33" 42"</p>	<p>Notes: - 6" Subfront to match - 24" sink cabinets has double door</p> <p>24" wide-22.5" sink clearance 30" wide-28.5" sink clearance 33" wide-31.5" sink clearance 36" wide-34.5" sink clearance 39" wide-37.5" sink clearance 42" wide-40.5" sink clearance</p>

<p>22 SINK FALSE FRONT</p>		<p>34-½" High x 24" Deep</p> <p>Width options: 24" 36" 30" 39" 33" 42"</p>	<p>Notes: - Top piece is a false front - 24" sink cabinets has double door</p> <p>24" wide-22.5" sink clearance 30" wide-28.5" sink clearance 33" wide-31.5" sink clearance 36" wide-34.5" sink clearance 39" wide-37.5" sink clearance 42" wide-40.5" sink clearance</p>
<p>23 SINK FARMHOUSE</p>		<p>34-½" High x 24" Deep</p> <p>Width options: 33" 36" 39"</p>	<p>Notes: -39" has a 2" center stile behind doors -Has fixed shelf at bottom of false front. -False front 10" tall (the clearance inside is 9.5")</p> <p>33" wide has 31.5" clearance 36" wide has 34.5" clearance 39" wide has 37.5" clearance</p>
<h1>COOK BASES</h1>			
<p>24 MICROWAVE BUILT IN</p>		<p>34-½" High x 24" Deep</p> <p>Width options: 27"</p>	<p>Notes: -Finished Interior to match doors drawers except Roma and Modello finished to match casework. -Shelves and holes not included -Opening is 25.5"w x 13-¾" tall</p>

v 4.2.1

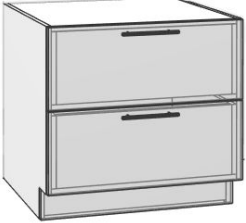
<p>25 MICROWAVE DRAWER</p>		<p>34-1/2" High x 24" Deep</p> <p>Width options: 24" 30"</p>	<p>Notes: -Microwave Drawer accepts -Sharp Microwave Drawer only- -Appliance manufacturer supplied trim kit required</p>
<p>26 COOKTOP w/ DRAWERS</p>		<p>34-1/2" High x 24" Deep</p> <p>Width options: 30" 33" 36" 39"</p>	<p>Notes: - Top drawer is a false front - Clear area for cooktop is 6 1/8" high.</p> <p>30" wide has 28.5" clearance 33" wide has 31.5" clearance 36" wide has 34.5" clearance 39" wide has 37.5" clearance</p>
<p>27 COOKTOP w/ DOORS</p>		<p>34-1/2" High x 24" Deep</p> <p>Width options: 30" 33" 36" 39"</p>	<p>Notes: - Top drawer is a false front - Clear area for cooktop is 6 1/8" high. - Has 1 adjustable shelf, 14 1/2" deep</p> <p>30" wide has 28.5" clearance 33" wide has 31.5" clearance 36" wide has 34.5" clearance 39" wide has 37.5" clearance</p>
<p>28 RANGE BASE</p>		<p>28-3/16" High x 24" Deep</p> <p>Width options: 30" 36"</p>	<p>Notes: - Includes a full top -Drawer boxes are 8" high if dovetail, 7 13/16" Legra, or 5 7/8" Metabox</p>

FLOATING SHELF

<p>29 3" FLOATING SHELF</p>		<p>3" High x 10" Deep</p> <p>Width options: 24" 42" 30" 48" 36"</p>	<p><i>Shelf Notes:</i> -Finished 3-sides, back edge is not finished -Square edge only -Weight limit 10 lbs per linear foot if mounted into studs</p> <p><i>Bracket Notes:</i> -Order Hanger Bracket separately -Hanger strip is sized for a 48" shelf, and can be trimmed on site to any smaller size -Metal bracket arms are 3"W x 1 5/8" H x 8 3/8" D</p>
------------------------------------	---	--	---

12"high WALL MOUNT

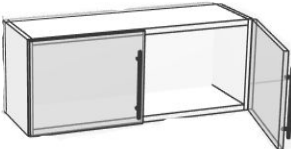
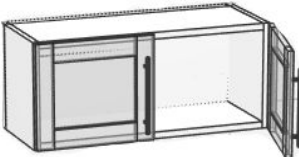
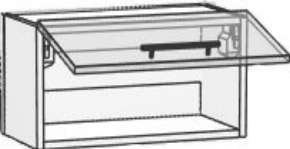
<p>30 12"high</p>		<p>12" High x 12" Deep</p> <p>Width options: 12" 21" 33" 15" 24" 36" 18" 27" 39" 30" 42"</p>	<p>Notes: -39" & 42" have a 2" center stile behind doors. -Cabinets 24" wide and less have 1 door. -Install hinge as R or L</p>
<p>31 12"high GLASS READY</p>		<p>12" High x 12" Deep</p> <p>Width options: 18" 30"</p>	<p>Notes: -Interiors finished to match doors and drawers -Available in painted and wood -Shakerframe that holds glass is made of the same material as doors and drawers -Glass not included -Door opens up 90 degrees. -Install hinge as R or L -18" wide cabinet has 1 door</p>
<p>32 12"high LIFT UP</p>		<p>12" High x 12" Deep</p> <p>Width options: 24" 30" 36"</p>	<p>Notes: -Door opens up 90 degrees. -Lift system used is Blum Aventos HK Stay Lift. -Available in wood and painted doors only.</p>

v 4.2.1

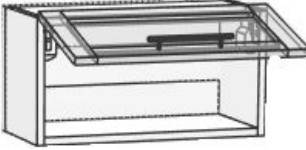
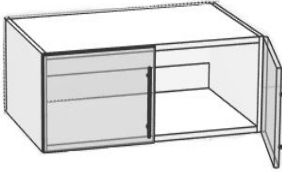
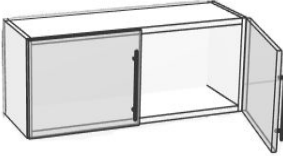
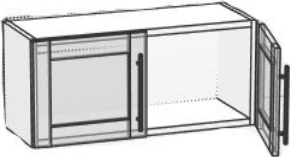
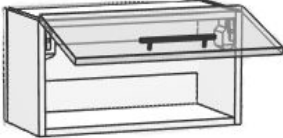
<p>33 12"high LIFT UP GLASS READY</p>		<p>12" High x 12" Deep</p> <p>Width options: 24" 30" 36"</p>	<p>Notes: -Interiors finished to match doors and drawers -Available in painted and wood -Shakerframe that holds glass is made of the same material as doors and drawers -Glass not included -Door opens up 90 degrees. -Lift system used is Blum Aventos HK Stay Lift.</p>
<p>34 12"high + 24" DEEP</p>		<p>12" High x 24" Deep</p> <p>Width options: 24" 36" 33" 39"</p>	<p>Notes: -Double door -Does not include shelves or shelf holes - The 39" wide includes a 2" center stile finished in the door color</p>
<h2>15"high WALL MOUNT</h2>			
<p>35 15"high</p>		<p>15" High x 12" Deep</p> <p>Width options: 12" 21" 33" 15" 24" 36" 18" 27" 39" 30" 42"</p>	<p>Notes: -39" and 42" have 2" center stile behind doors. -Install hinge as R or L - Cabinets 24" wide and less have 1 door</p>
<p>36 15"high GLASS READY</p>		<p>15" High x 12" Deep</p> <p>Width options: 18" 30"</p>	<p>Notes: -Interiors finished to match doors and drawers -Available in painted and wood -Shakerframe that holds glass is made of the same material as doors and drawers -Glass not included -Install hinge as R or L -18" wide cabinet has 1 door</p>
<p>37 15"high LIFT UP</p>		<p>15" High x 12" Deep</p> <p>Width options: 24" 30" 36"</p>	<p>Notes: -Door opens up 90 degrees Lift system used is Blum Aventos HK Stay Lift. -Available in wood and painted doors only.</p>

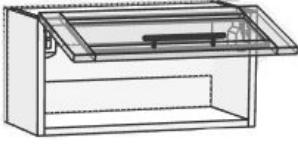
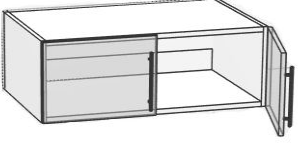
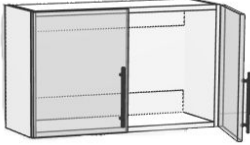
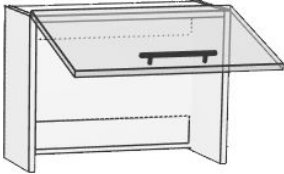
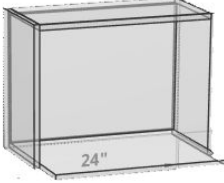
<p>38 15"high LIFT UP GLASS READY</p>		<p>15" High x 12" Deep</p> <p>Width options: 24" 30" 36"</p>	<p>Notes: -Interiors finished to match doors and drawers -Available in painted and wood -Shakerframe that holds glass is made of the same material as doors and drawers -Glass not included -Door opens up 90 degrees. -Lift system used is Blum Aventos HK Stay Lift.</p>
<p>39 15"high + 24" DEEP</p>		<p>15" High x 24" Deep</p> <p>Width options: 24" 36" 33" 39"</p>	<p>Notes: -Double door -Does not include shelves or shelf holes - The 39" wide includes a 2" center stile finished in the door color</p>
<h2>18"high WALL MOUNT</h2>			
<p>40 18"high</p>		<p>18" High x 12" Deep</p> <p>Width options: 30" 36"</p>	<p>Notes: -This size is typically used above appliances.</p>
<p>41 18"high APPLIANCE GARAGE</p>		<p>18" High x 12" Deep</p> <p>Width options: 24"</p>	<p>Notes: -Clearance with door open is 15.5". - Sides come finished to match doors.</p>
<p>42 18"high MICROWAVE</p>		<p>18" High x 18" Deep</p> <p>Width options: 24"</p>	<p>Notes: -Opening is 21.5" wide by 15.75" tall -Shelf depth is 17.25" -Comes with loose shelf</p>

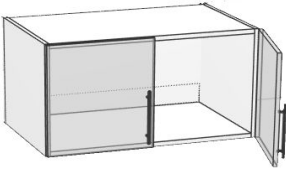
<p>43 18"high + 24" DEEP</p>		<p>18" High x 24" Deep</p> <p>Width options: 24" 36" 33" 39"</p>	<p>Notes: -Double door -Does not include shelves or shelf holes - The 39" wide includes a 2" center stile finished in the door color</p>
---	---	---	---

21"high WALL MOUNT

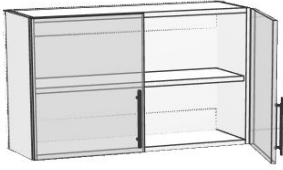

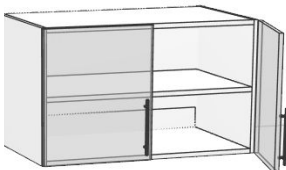
<p>44 21"high</p>		<p>21" High x 12" Deep</p> <p>Width options: 24" 30" 36" 42"</p>	<p>Notes: -39" & wider have 2" center stile - 24" wide have 1 door. - Install hinge as R or L</p>
--------------------------	---	---	--

<p>45 21"high + 24" DEEP</p>		<p>21" High x 24" Deep</p> <p>Width options: 24" 36" 33" 39"</p>	<p>Notes: -Double door -Does not include shelves or shelf holes - The 39" wide includes a 2" center stile finished in the door color</p>
---	---	---	---

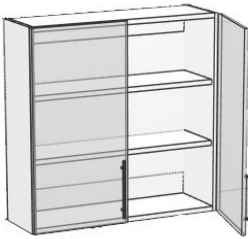
30"high WALL MOUNT

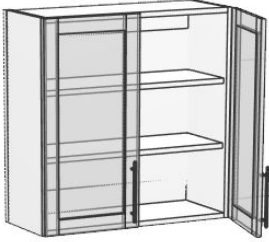

<p>46 30"high</p>		<p>30" High x 12" Deep</p> <p>Width options: 12" 21" 33" 15" 24" 36" 18" 27" 39" 30" 42"</p>	<p>Notes: -39" and wider have 2" center stile. - Cabinets 24" wide and less have 1 door. - Install hinge as R or L.</p>
--------------------------	---	--	--

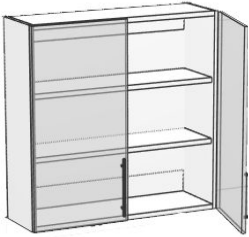
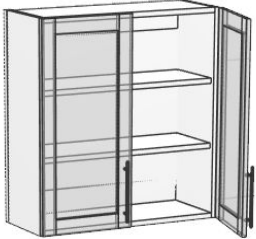
v 4.2.1

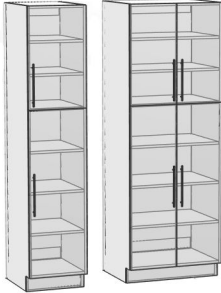

<p>47 30"high GLASS</p>		<p>30" High x 12" Deep</p> <p>Width options: 18" 30"</p>	<p>Notes: -Interiors finished to match doors and drawers -Available in painted and wood -Shakerframe that holds glass is made of the same material as doors and drawers -Glass not included - Cabinets 24" wide and less have 1 door. - Install hinge as R or L</p>
<p>48 30"high OPEN SHELVES</p>		<p>30" High x 12" Deep</p> <p>Width options: 12" 24" 15" 30" 18"</p>	<p>Notes: -Finished to match doors</p>
<h2>39"high WALL MOUNT</h2>			
<p>49 39"high</p>		<p>39" High x 12" Deep</p> <p>Width options: 12" 21" 33" 15" 24" 36" 18" 27" 39" 30" 42"</p>	<p>Notes: -39" and wider have 2" center stile - Cabinets 24" wide and less have 1 door. - Install hinge as R or L</p>
<p>50 39"high GLASS READY</p>		<p>39" High x 12" Deep</p> <p>Width options: 18" 30"</p>	<p>Notes: -Interiors finished to match doors and drawers -Available in painted and wood -Shakerframe that holds glass is made of the same material as doors and drawers -Glass not included - Cabinets 24" wide and less have 1 door. - Install hinge as R or L</p>

<p>51 39"high OPEN</p>		<p>39" High x 12" Deep</p> <p>Width options:</p> <p>12" 24" 15" 30" 18"</p>	<p>Notes: -Finished to match doors -Matching veneer edgebanding is standard on stain and paint orders -Peg holes predrilled -(3) adjustable shelves</p>
-----------------------------------	---	--	--

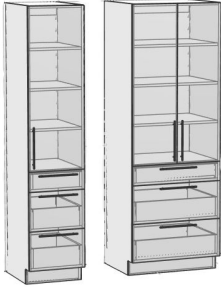
84"high PANTRY & OVEN CABINETS



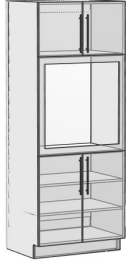
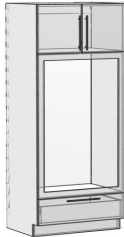

<p>52 84" PANTRY w/SHELVES</p>		<p>84"High x 24" Deep</p> <p>Width options:</p> <p>12" 18" 15" 24" 30"</p>	<p>Notes: -Cabinets 24" wide and less have single door wide, specify right (R) or left (L) hinge and 30" has double door wide -Shaker style doors have center rail on lower door -(5) Full-depth shelves included</p>
<p>53 84" PANTRY w/ROLL OUTS</p>		<p>84"High x 24" Deep</p> <p>Width options:</p> <p>18" 24" 30"</p>	<p>Notes: -Cabinets 24" wide and less have single door wide, specify right (R) or left (L) hinge and 30" has double door wide -Shaker style doors have center rail on lower door -(4) Rollout Drawers included</p>
<p>54 84" UTILITY 3 DRAWERS</p>		<p>84"High x 24" Deep</p> <p>Width options:</p> <p>15" 24" 18" 30"</p>	<p>Notes: -Includes 3 full-depth adjustable shelves -Cabinets 24" wide and less have single door, specify right (R) or left (L) hinge and 30" has double door -Shaker style doors have center rail on door -Drawers align with base cabinet height.</p>

v 4.2.1

<p>55 84" OVEN SINGLE</p>		<p>84"High x 24" Deep</p> <p>Width options: 33"</p>	<p>Notes:</p> <ul style="list-style-type: none"> -30-5/8" opening -Frame has 5" top/bottom rails and 3 1/2" sides. -Flat door oven panels are solid MDF (no cut out) -(2) shelves -Oven panel ships clipped to cabinet
<p>56 84" OVEN MICRO COMBO</p>		<p>84"High x 24" Deep</p> <p>Width options: 33"</p>	<p>Notes:</p> <ul style="list-style-type: none"> -51-1/8" opening -Frame has 5" top/bottom rails and 3 1/2" sides. -Flat door oven panels are solid MDF (no cut out) -No shelves -Oven panel ships clipped to cabinet
<p>57 84" OVEN DOUBLE</p>		<p>84"High x 24" Deep</p> <p>Width options: 33"</p>	<p>Notes:</p> <ul style="list-style-type: none"> -57-1/8" opening -Frame has 5" top/bottom rails and 3 1/2" sides. -Flat Door oven panels are solid MDF (no cut out) -No shelves -Oven panel ships clipped to cabinet

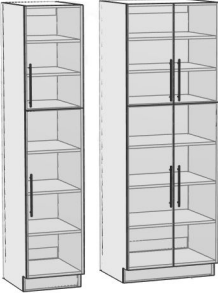
93"high PANTRY & OVEN CABINETS

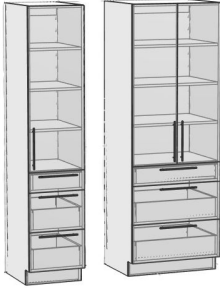
v 4.2.1

<p>58 93" PANTRY w/SHELVES</p>		<p>93"High x 24" Deep</p> <p>Width options:</p> <p>12" 18" 15" 24" 30"</p>	<p>Notes:</p> <ul style="list-style-type: none"> -Cabinets 24" wide and less have single door wide, specify right (R) or left (L) hinge and 30" has double door wide -Shaker style doors have center rail on lower door -(5) Full-depth shelves included
<p>59 93" PANTRY w/ROLL OUTS</p>		<p>93"High x 24" Deep</p> <p>Width options:</p> <p>18" 24" 30"</p>	<p>Notes:</p> <ul style="list-style-type: none"> -Cabinets 24" wide and less have single door wide, specify right (R) or left (L) hinge and 30" has double door wide -Shaker style doors have center rail on lower door -(4) Rollout Drawers included
<p>60 93" UTILITY 3 DRAWERS</p>		<p>93"High x 24" Deep</p> <p>Width options:</p> <p>15" 24" 18" 30"</p>	<p>Notes:</p> <ul style="list-style-type: none"> -Includes (4) full-depth adjustable shelves -Cabinets 24" wide and less have single door, specify right (R) or left (L) hinge and 30" has double door -Shaker style doors have center rail on door -Drawers align with base cabinet height
<p>61 93" OVEN SINGLE</p>		<p>93"High x 24" Deep</p> <p>Width options:</p> <p>33"</p>	<p>Notes:</p> <ul style="list-style-type: none"> -31-5/8" opening Frame has 5" top/bottom rails and 3 1/2" sides. -Flat Door oven panels are solid MDF (no cut out) -(3) shelf -Oven panel ships clipped to cabinet
<p>62 93" OVEN MICRO COMBO</p>		<p>93"High x 24" Deep</p> <p>Width options:</p> <p>33"</p>	<p>Notes:</p> <ul style="list-style-type: none"> -51-1/8" opening -Frame has 5" top/bottom rails and 3 1/2" sides. -Flat door oven panels are solid MDF (no cut out) -(1) shelf -Oven panel ships clipped to cabinet

v 4.2.1

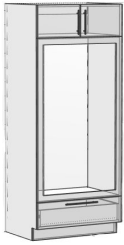
<p>63 93" OVEN DOUBLE</p>		<p>93" High x 24" Deep</p> <p>Width options: 33"</p>	<p>Notes:</p> <ul style="list-style-type: none"> -57-1/8" opening -Frame has 5" top/bottom rails and 3 1/2" sides. -Flat door oven panels are solid MDF (no cut out) -(1) shelf -Oven panel ships clipped to cabinet
--------------------------------------	---	---	--

CORNER WALL MOUNT

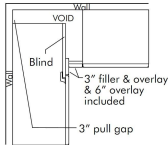
<p>64 BLIND CORNER</p>		<p>27" Wide x 12" Deep</p> <p>Height options: 15" 30" 39"</p>	<p>Notes:</p> <ul style="list-style-type: none"> -Use as Right or Left hinge -Actual cabinet width is 24" which accounts for pulling cabinet 3" away from wall to allow door to open 
<p>65 HINGED CORNER</p>		<p>24" Wide x 12" Deep</p> <p>Height options: 30" 39"</p>	<p>Notes:</p> <ul style="list-style-type: none"> -24" wide on each side -Door has knuckle hinge -no accessories included -Can be flipped to have left or right opening

100 SERIES FINISHING PANELS & MOLDING

For Wood and Paint finishes

v 4.2.1

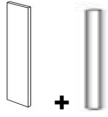
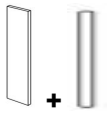
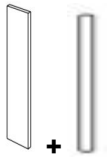
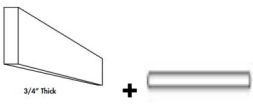
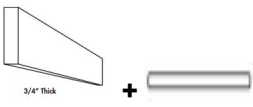
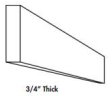
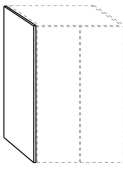
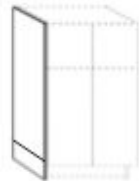
<p>101 WALL FILLER</p>		<p>4" x 42" x 3/4" thick 1.5" x 42" x 3/4" thick</p>	<p>Notes: -Finished on 1-side and all edges -Grain runs the 96" length -Comes as a pack of (2). Installer can mount separately or build cleat.</p>
<p>102 BASE FILLER</p>		<p>4" x 36" x 3/4" thick 1.5" x 36" x 3/4" thick</p>	
<p>103 TALL FILLER</p>		<p>4" x 96" x 3/4" thick 1.5" x 96" x 3/4" thick</p>	
<p>104 CROWN</p>		<p>6" x 96" x 3/4" thick 1.5" x 96" x 3/4" thick</p>	
<p>105 LIGHT RAIL</p>		<p>1.5" x 96" x 3/4" thick 1.5" x 96" x 3/4" thick</p>	
<p>106 TOE KICK</p>		<p>6" x 96" x 3/4" thick</p>	<p>Notes: -Finished on 1-side and all edges -Grain runs the 96" length</p>
<p>107 ECONOMY PANEL OPTION Finished on a single side of the panel only. Uses toekick wrap around to finish off panel.</p>			
<p>Wall Panel</p>		<p>15" x 42" x 3/4" thick</p>	<p>Notes: -Finished on 1 side & all edges -Grain runs long direction.</p>
<p>Base Panel</p>		<p>27" x 29.8" x 3/4" thick</p>	<p>Notes: -Finished on 1 side & all edges</p>

v 4.2.1

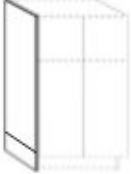
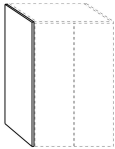
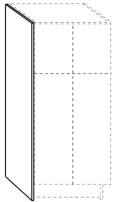
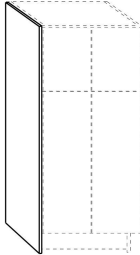
Tall Panel		<p>27" x 93" x 3/4" thick</p>	<p>-Grain runs long direction. -Toe kick wraps around panel -Toe kick grain direction will be horizontal and panel grain direction will be vertical.</p>
Island & Peninsula		<p>25.75" x 29.8" x 3/4" thick</p>	<p>Notes: -Finished on 1-side & all edges -Grain runs long direction. -Toe kick wraps around panel -Toe kick grain direction will be horizontal and panel grain direction will be vertical. -Back panel is fitted inset to the island & peninsula panel -Create the back panel for island or peninsula by #110 Custom Panels. -Order panel 36"h x width of island. Oversize is suggested</p>
<p>108 EURO PANEL OPTION Finished on both sides. Panel runs straight to floor.</p>			
Wall Panel		<p>15" x 42" x 3/4" thick</p>	<p>Notes: -Finished on 2 sides & all edges -Grain runs long direction.</p>
Base Panel		<p>27" x 36" x 3/4" thick</p>	<p>Notes: -Finished on 2-sides & all edges -Grain runs long direction. -Panel runs straight to the floor, no notch for toe kick. -Toe kick grain direction will be horizontal and panel grain direction will be vertical.</p>
Tall Panel		<p>27" x 96" x 3/4" thick</p>	<p>Notes: -Finished on 2-sides & all edges -Grain runs long direction. -Panel runs straight to the floor, no notch for toe kick. -Toe kick grain direction will be horizontal and panel grain direction will be vertical.</p>

v 4.2.1

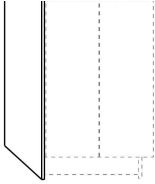
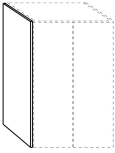
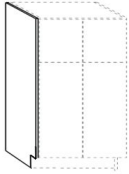
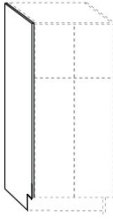
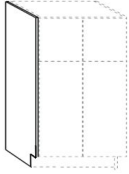
Island & Peninsula		25.75" x 36" x 3/4" thick	<p>Notes:</p> <ul style="list-style-type: none"> -Finished on 2-sides & all edges -Grain runs long direction. -Panel runs straight to the floor, no notch for toe kick. -Toe kick grain direction will be horizontal and panel grain direction will be vertical. -Back panel is fitted inset to the island & peninsula panel -Order custom sized back panel 36"h x width of island. Oversize is suggested
<p>109 CLASSIC PANEL OPTION Finished on both sides. Panel is notched and runs straight to floor.</p>			
Wall Panel		15" x 42" x 3/4" thick	<p>Notes:</p> <ul style="list-style-type: none"> -Finished on 2-sides & all edges -Grain runs long direction.
Base Panel		27" x 36" x 3/4" thick	<p>Notes:</p> <ul style="list-style-type: none"> -Finished on 2-sides & all edges -Grain runs long direction. -Panel runs straight to the floor, with a notch for the toe kick. -Toe kick grain direction will be horizontal and panel grain direction will be vertical.
Tall Panel		27 x 93" x 3/4" thick	
Island & Peninsula		25.75" x 36" x 3/4" thick	<p>Notes:</p> <ul style="list-style-type: none"> -Finished on 2-sides & all edges -Grain runs long direction. -Panel runs straight to the floor, with a notch for the toe-kick. -Toe kick grain direction will be horizontal and panel grain direction will be vertical. -Back panel is fitted inset to the

v 4.2.1



			<p>island & peninsula panel -Create the back panel for island or peninsula by #110 Custom Panels. -Order panel 36" h x width of island. Oversize is suggested</p>
110 DOOR GLASS STRIP		50' Roll	<p>Notes -Holds glass in place in the shaker doors prepped for glass. Flat doors use a bead of silicone.</p>
111 FINISHING KIT	The finishing kit is made of useful extras that may help during installation, decorating, or future repairs.	For all wood and painted finishes.	<p>Includes: -1 pint of zero VOC paint to match -12" x 12" Decorator Sample -Extra shelf pins -105 Door and drawer bumpers -4 Door restrictor plates -15 linear feet of edgebanding -53 Fast Fix Caps</p>

200 SERIES FINISHING PANELS & MOLDING

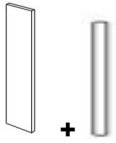
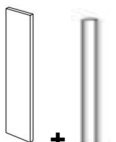
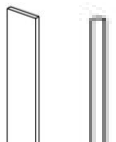
For Price Roma and Modello Finishes

201 WALL FILLER		4" x 42" x 3/4" thick 1.5" x 42" x 3/4" thick	<p>Notes: -Finished on 1-side and all edges -Grain runs the 96" length -Comes as a pack of (2). Installer can mount separately or build cleat.</p>
202 BASE FILLER		4" x 36" x 3/4" thick 1.5" x 36" x 3/4" thick	
203 TALL FILLER		4" x 96" x 3/4" thick 1.5" x 96" x 3/4" thick	

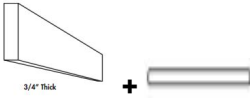
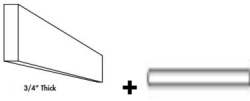
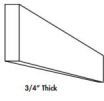
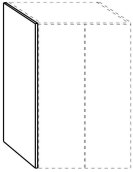
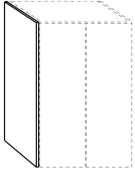
v 4.2.1

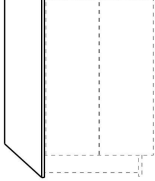
<p>204 CROWN</p>		<p>6" x 96" x 3/4" thick 1.5" x 96" x 3/4" thick</p>	<p>Notes: -Finished on 1-side and all edges -Grain runs the 96" length -Consists of 2 pieces. Installer can mount separately or build cleat.</p>
<p>205 LIGHT RAIL</p>		<p>(2) 1.5" x 96" x 3/4" thick</p>	<p>Notes: -Finished on 1-side and all edges -Grain runs the 96" length -Comes as a pack of (2). Installer can mount separately or build cleat.</p>
<p>206 TOE KICK</p>		<p>6" x 96" x 3/4" thick</p>	<p>Notes: -Finished on 1-side and all edges -Grain runs the 96" length</p>
<p>207 EURO PANEL OPTION Finished on both sides. Panel runs straight to floor.</p>			
<p>Wall Panel</p>		<p>15" x 42" x 3/4" thick</p>	<p>Notes: -Finished on 2-sides & all edges -Grain runs long direction.</p>
<p>Base Panel</p>		<p>27" x 36" x 3/4" thick</p>	<p>Notes: -Finished on 2-sides & all edges -Grain runs long direction.</p>
<p>Tall Panel</p>		<p>27 x 93" x 3/4" thick</p>	<p>-Panel runs straight to the floor, no notch.</p>
<p>Island & Peninsula</p>		<p>25.75" x 36" x 3/4" thick</p>	<p>Notes: -Finished on 2-sides & all edges -Grain runs long direction. -Panel runs straight to the floor, no notch for toe kick. -Toe kick grain direction will be horizontal and panel grain direction will be vertical. -Back panel is fitted inset to the island & peninsula panel</p>

v 4.2.1

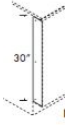
			-Order custom sized back panel 36" h x width of island. Oversize is suggested
208 HEAT SHIELDS		2 in a set	Notes: -Heat Shields are 1/16" thick white epoxy coated metal -Goes on either side of the oven to protect the cabinets from heat.
209 FINISHING KIT	The finishing kit is made of useful extras that may help during installation, decorating, or future repairs.	For Thermofoil, Modello and Roma finishes.	Notes: -12" x 12" Decorator Sample -Extra shelf pins -105 Door and drawer bumpers -4 Door restrictor plates -15 linear feet of edgbanding -53 Fast Fix Caps

300 SERIES FINISHING PANELS & MOLDING

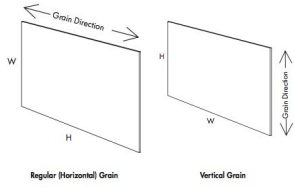
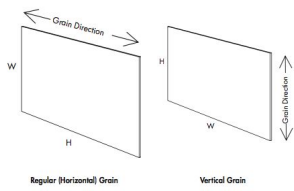
301 CUSTOM PANEL		Width x Height x 3/4" thick	Notes: -Materia/construction is slab MDF w/ veneer to match -Square edge profile -Edgeband on all sides -Finished on both sides -Grain direction runs with height -Max size 43" wide x 96" high. Square Feet = W" x H" / 144
302 CUSTOM APPLIANCE PANEL		Width x Height x 3/4" thick	Notes: -Materia/construction matches door style selected -Edge profile matches door front (slight ease or square edge) -Finished on both sides -Grain direction runs with height (refer to grain direction on drawer; varies with finish, see catalog for details) -Max size 43" wide x 96" high. Square Feet = W" x H" / 144